



T 514

DVD / CD / MP3 Player

ENGLISH



Owner's Manual

Introduction

SAFETY PRECAUTIONS

WARNING: TO REDUCE THE RISK OF FIRE OR ELECTRIC SHOCK, DO NOT EXPOSE THIS PRODUCT TO RAIN OR MOISTURE

CAUTION

THIS DVD PLAYER EMPLOYS A LASER SYSTEM. TO ENSURE PROPER USE OF THIS PRODUCT, PLEASE READ THIS OWNER'S MANUAL CAREFULLY AND RETAIN FOR FUTURE REFERENCE. SHOULD THE UNIT REQUIRE MAINTENANCE, CONTACT AN AUTHORIZED SERVICE LOCATION.

USE OF CONTROLS, ADJUSTMENTS TO MODIFY PERFORMANCE OF PROCEDURES OTHER THAN THOSE SPECIFIED MAY RESULT IN HAZARDOUS RADIATION EXPOSURE.

TO PREVENT DIRECT EXPOSURE TO LASER BEAM, DO NOT TRY TO OPEN THE ENCLOSURE. VISIBLE LASER RADIATION EXISTS WHEN THE ENCLOSURE IS OPENED. DO NOT STARE INTO BEAM.

THE APPARATUS SHOULD NOT BE EXPOSED TO DRIPPING OR SPLASHING, AND OBJECTS FILLED WITH LIQUIDS, SUCH AS VASES, SHOULD NEVER BE PLACED ON THE APPARATUS.

WARNING: CHANGES OR MODIFICATIONS NOT EXPRESSLY APPROVED BY THE PARTY RESPONSIBLE FOR COMPLIANCE COULD VOID THE USER'S AUTHORITY TO OPERATE THE EQUIPMENT.

This product is manufactured to comply with the radio interference requirements of EEC DIRECTIVE 89/336/EEC, 93/68/EEC and 73/23/EEC.

NOTES ON COPYRIGHT

It is forbidden by law to copy, broadcast, show, broadcast via cable, play in public, or rent copyright material without permission. This product is equipped with copy protection measures developed by Macrovision. Copy protection signals are recorded on some discs. When recording these discs on a VCR, picture noise will appear during playback. This product incorporates copyright protection technology that is protected by certain U.S. patent claims and other intellectual property rights owned by Macrovision Corporation and other rights owners. Use of this copyright protection technology must be authorized by Macrovision Corporation, and is intended for home and other limited viewing uses only unless otherwise authorized by Macrovision Corporation. Reverse engineering or disassembly is prohibited.

RECORD YOUR MODEL NUMBER (NOW, WHILE YOU CAN SEE IT)

The model and serial number of your new DVD player are located on the back of the DVD player cabinet. For your future convenience, we suggest that you record these numbers here:

MODEL NO. _____

SERIAL NO. _____

INTRODUCTION

Safety precautions2
Before Use5
 Playable Discs4
 Disc-related terms4
 Types of video CDs4
 Precautions for handling the unit5
 Notes on Discs5
 About Symbols5
Rear Panel6
Front Panel and Display Window7
Remote control8

PREPARATION

Connections9
 Connecting to a TV9
 Connecting to Optional Equipment10
Before Operation11
 General Explanation11
 On-Screen Display11
 Initial Settings13
 Language13
 Picture13
 Sound14
 Speaker selection14
 Others15
 Parental Control15

OPERATION

Operation with DVD and Video CD17
 Playing a DVD and Video CD17
 General Features17
 Special DVD Features19
 Playing a DVD-VR format Disc20
Operation with Audio CD and MP3 / WMA Disc21
 Playing an Audio CD and MP3 / WMA Disc21
 Notes on MP3/WMA Recordings21
Operation with JPEG Disc23
 Viewing a JPEG disc23
Programmed Playback24
Additional Information25

REFERENCE

Troubleshooting26
Table of Languages and Their Abbreviations27
Country Code List28
Specifications29



Introduction

BEFORE USE

PLAYABLE DISCS



DVD video discs
(8 cm / 12 cm disc)



Video CD (VCD)
(8 cm / 12 cm disc)



Audio CD
(8 cm / 12 cm disc)

In addition, this unit can play a DVD-R, DVD±RW, Kodak PICTURE CD, SVCD, and CD-R or CD-RW that contains audio titles, MP3, WMA or JPEG files.

NOTES

- Depending on the conditions of the recording equipment or the CD-R/RW (or DVD-R/±RW) disc itself, some CD-R/RW (or DVD-R/±RW) discs cannot be played on the unit.
- Do not attach any seal or label to either side (the labeled side or the recorded side) of a disc.
- Do not use irregularly shaped CDs (e.g., heart-shaped or octagonal). It may result in malfunctions.

NOTES ON DVDS AND VIDEO CDS

Some playback operations of DVDs and Video CDs may be intentionally fixed by software manufacturers.

As this unit plays DVDs and Video CDs according to disc content designed by the software manufacturer, some playback features of the unit may not be available or other functions may be added.

Refer also to the instructions supplied with the DVDs and Video CDs. Some DVDs made for business purposes may not be played on the unit.

REGIONAL CODE OF THE DVD PLAYER AND DVDS

This DVD player is designed and manufactured for playback of region "1" encoded DVD software.

The region code on the labels of some DVD discs indicates which type of player can play those discs. This unit can play only DVD discs labeled "1" or "ALL". If you try to play any other discs, the message "Check Regional Code" will appear on the TV screen.

Some DVD discs may not have a region code label even though their playback is prohibited by area limits.

DISC-RELATED TERMS

TITLE (DVD VIDEO DISCS ONLY)

The main film content, accompanying feature content, additional feature content, or music album. Each title is assigned a title reference number enabling you to locate it easily.

CHAPTER (DVD VIDEO DISCS ONLY)

Sections of a picture or a musical piece that are smaller than titles. A title is composed of one or several chapters. Each chapter is assigned a chapter number, enabling you to locate the chapter you want. Depending on the disc, chapters may not be recorded.

TRACK (VIDEO CD AND AUDIO CD ONLY)

Sections of a picture or a musical piece on a video CD or an audio CD. Each track is assigned a track number, enabling you to locate the track you want.

SCENE

On a video CD with PBC (Playback control) functions, moving pictures and still pictures are divided into sections called "Scenes". Each scene is displayed in the menu screen and assigned a scene number, enabling you to locate the scene you want. A scene is composed of one or several tracks.

TYPES OF VIDEO CDS

There are two types of video CDs:

Video CDs equipped with PBC (Version 2.0)

PBC (Playback control) functions allow you to interact with the system via menus, search functions, or other typical computer-like operations. Moreover, still pictures of high resolution can be played if they are included in the disc.

Video CDs not equipped with PBC (Version 1.1)

Operated in the same way as audio CDs, these discs allow playback of video pictures as well as sound, but they are not equipped with PBC.

PRECAUTIONS FOR HANDLING THE UNIT**WHEN SHIPPING THE UNIT**

The original shipping carton and packing materials come in handy. For maximum protection, re-pack the unit as it was originally packed at the factory.

WHEN SETTING UP THE UNIT

The picture and sound of a nearby TV, VCR, or radio may be distorted during playback. In this case, position the unit away from the TV, VCR, or radio, or turn off the unit after removing the disc.

TO KEEP THE EXTERIOR SURFACES CLEAN

Do not use volatile liquids, such as insecticide spray, near the unit. Do not leave rubber or plastic products in contact with the unit for a long period of time. They will leave marks on the surface.

TO CLEAN THE CABINET

Use a soft, dry cloth. If the surfaces are extremely dirty, use a soft cloth lightly moistened with a mild detergent solution. Do not use strong solvents such as alcohol, benzene, or thinner, as these might damage the surface of the unit.

TO OBTAIN A CLEAR PICTURE

The DVD player is a high-tech, precision device. If the optical pick-up lens and disc drive parts are dirty or worn, the picture quality will be poor. Regular inspection and maintenance are recommended after every 1,000 hours of use. (This depends on the operating environment.) For details, please contact your nearest dealer.

NOTES ON DISCS**HANDLING DISCS**

Do not touch the playback side of the disc. Hold the disc by the edges so that fingerprints will not get on the surface. Do not stick paper or tape on the disc.

**STORING DISCS**

After playing, store the disc in its case.

Do not expose the disc to direct sunlight or sources of heat, or leave it in a parked car exposed to direct sunlight, as there may be a considerable temperature increase inside the car.

CLEANING DISCS

Fingerprints and dust on the disc can cause poor picture quality and sound distortion. Before playing, clean the disc with a clean cloth. Wipe the disc from the center out.







Do not use strong solvents such as alcohol, benzene, thinner, commercially available cleaners, or anti-static spray intended for older vinyl records.

**ABOUT SYMBOLS****ABOUT THE  SYMBOL DISPLAY**

"" may appear on the TV screen during operation. This icon means the function explained in this owner's manual is not available on that specific DVD video disc.

ABOUT THE DISC SYMBOLS FOR INSTRUCTIONS

A section whose title has one of the following symbol is applicable only to the disc represented by the symbol.

-  DVD Video discs
-  Video CDs with the PBC (playback control) function
-  Video CDs without the PBC (playback control) function
-  Audio CDs
-  MP3 disc
-  WMA disc
-  JPEG disc

Introduction

REAR PANEL

ENGLISH

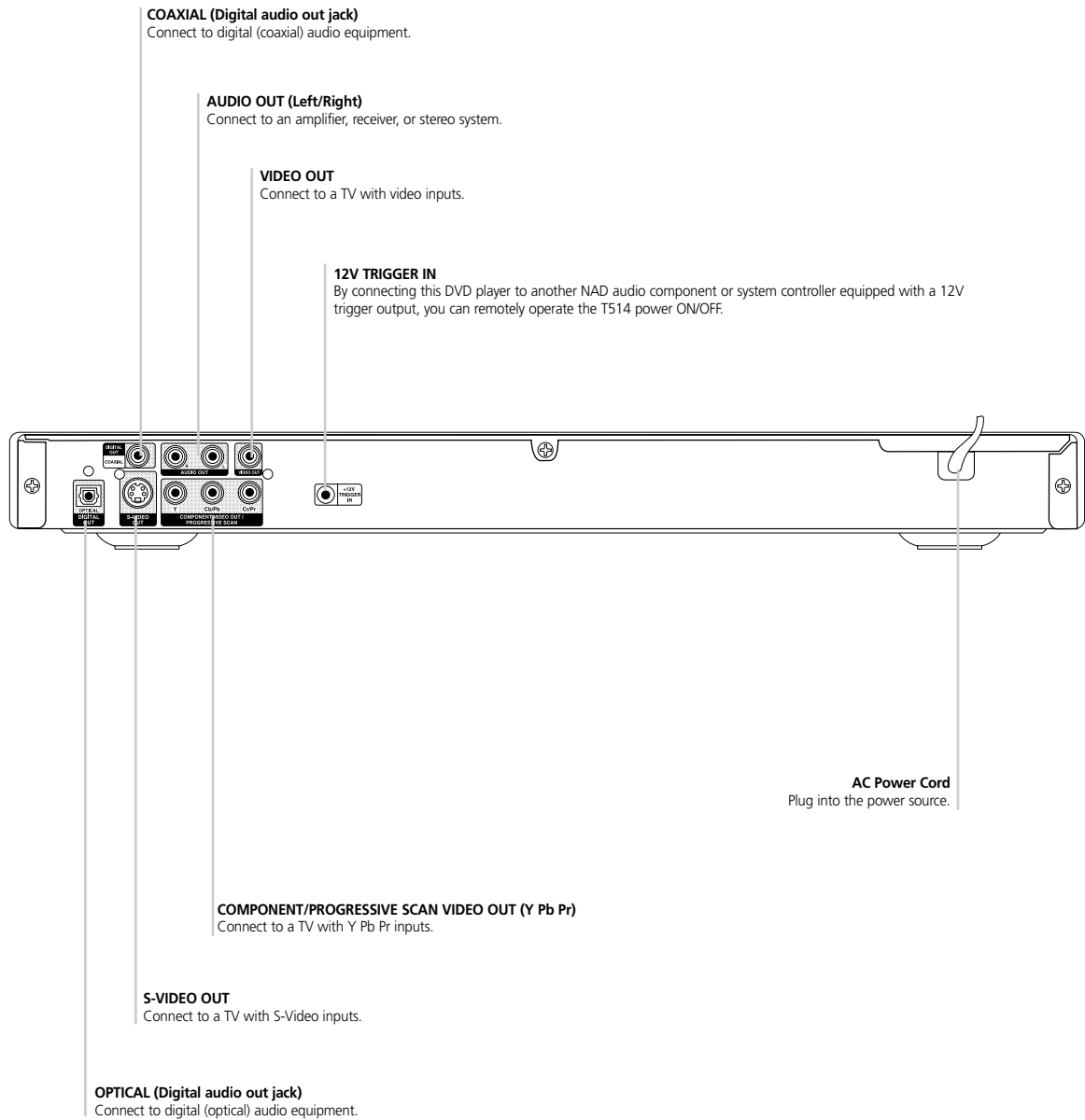

**DO NOT TOUCH THE INNER PINS OF THE CONNECTORS ON THE REAR PANEL.
ELECTROSTATIC DISCHARGE MAY CAUSE PERMANENT DAMAGE TO THE UNIT.**

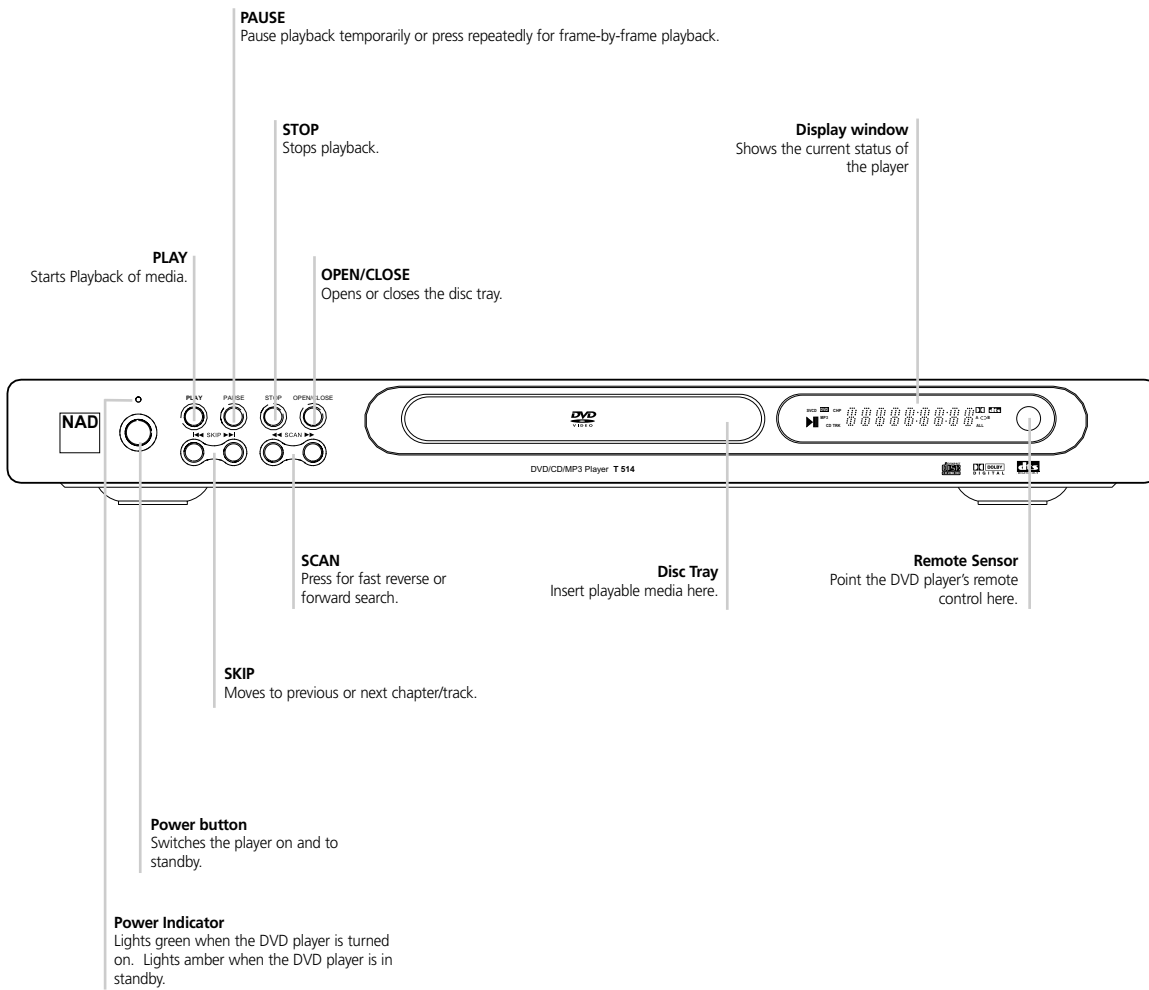

- DVD video disc inserted
- CD Audio CD inserted
- VCD Video CD inserted
- MP3 MP3 or WMA disc inserted

CHP/TRK Indicates current chapter or track number

Indicates total play time or elapsed time

Indicates repeat mode

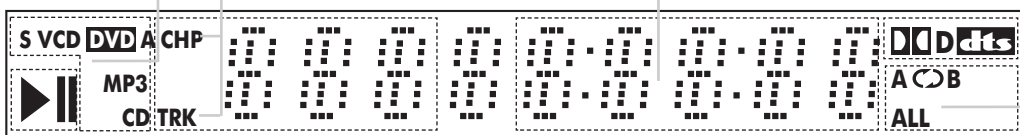

Introduction

REMOTE CONTROL

ENGLISH

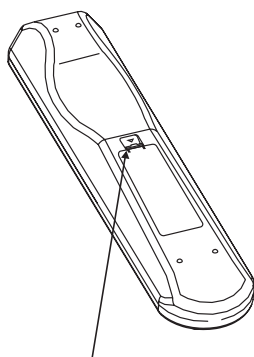
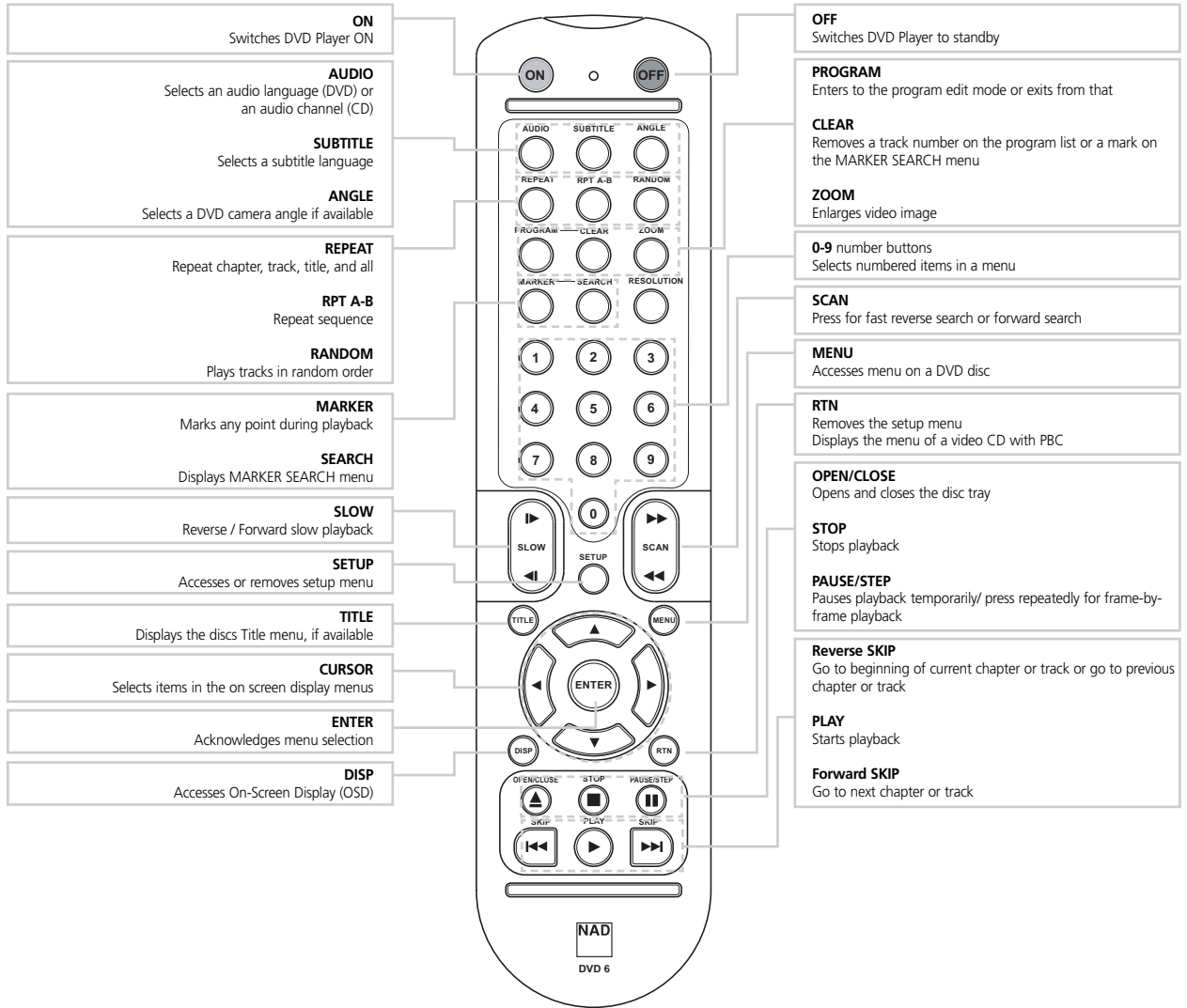

PRESS IN AND LIFT TAB TO REMOVE BATTERY COVER OUT OF RECESS

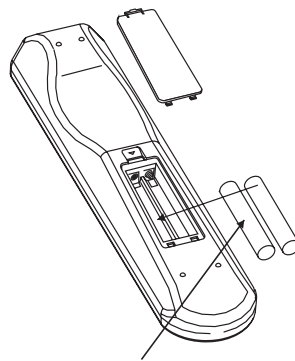

PLACE BATTERIES INTO OPENING. ENSURE THE CORRECT FITTING IS OBSERVED

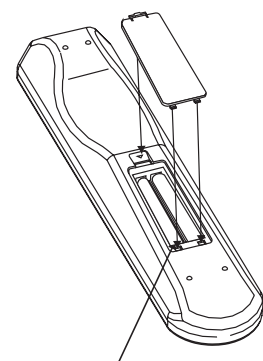

REPLACE BATTERY COVER BY ALIGNING AND INSERTING THE TWO TABS INTO THE HOLES.

PRESS BATTERY COVER INTO PLACE UNTIL IT 'CLICKS' CLOSED

REMOTE CONTROL OPERATION RANGE

Point the remote control at the remote sensor and press the buttons.

Distance: About 23 ft (7 m) from the front of the remote sensor.

Angle: About 30° in each direction of the front of the remote sensor.

CAUTION

Do not mix old and new batteries. Never mix different types of batteries (standard, alkaline, etc.).

- Depending on your TV and other equipment you wish to connect, there are various ways you could connect the player. Use only one of the connections described below.
- Please refer to the manuals of your TV, VCR, Stereo System or other devices as necessary to make the best connections.
- For better sound reproduction, connect the player's AUDIO OUT connectors to the audio in connectors of your amplifier, receiver, stereo or audio/video equipment. See "Connecting to Optional Equipment" on page 10.

CAUTION

- Make sure the DVD Player is connected directly to the TV. Tune the TV to the correct video input channel.
- Do not connect the DVD Player's AUDIO OUT jack to the phono in jack (record deck) of your audio system.
- Do not connect your DVD Player via your VCR. The DVD image could be distorted by the copy protection system.

CONNECTING TO A TV

- Make one of the following connections, depending on the capabilities of your existing equipment.

VIDEO CONNECTION

- 1 Connect the VIDEO OUT jack on the DVD Player to the video in jack on the TV using the video cable (V).
- 2 Connect the Left and Right AUDIO OUT connectors of the DVD Player to the audio left/right in connectors on the TV using the audio cables (A).

S-VIDEO CONNECTION

- 1 Connect the S-VIDEO OUT jack on the DVD Player to the S-Video in jack on the TV using the S-Video cable (S).
- 2 Connect the Left and Right AUDIO OUT connectors of the DVD Player to the audio left/right in connectors on the TV using the audio cables (A).

COMPONENT VIDEO (COLOR STREAM®) CONNECTION

- 1 Connect the COMPONENT VIDEO OUT/ PROGRESSIVE SCAN connectors on the DVD Player to the corresponding in connectors on the TV using an Y / Pb / Pr cable (C).
- 2 Connect the Left and Right AUDIO OUT connectors of the DVD Player to the audio left/right in connectors on the TV using the audio cables (A).

PROGRESSIVE SCAN CONNECTION

- If your television is a high-definition or "digital ready" television, you may take advantage of the DVD Player's progressive scan output for the highest video resolution possible.
- If your TV does not accept the Progressive Scan format, the picture will appear scrambled if you try Progressive Scan on the DVD Player.

- 1 Connect the COMPONENT VIDEO OUT/ PROGRESSIVE SCAN connectors on the DVD Player to the corresponding in connectors on the TV using an optional Y Pb Pr cable (C).
- 2 Connect the Left and Right AUDIO OUT connectors of the DVD Player to the audio left/right in connectors on the TV using the supplied audio cables (A).

NOTES

- Set the Progressive to "On" on the setup menu for progressive signal, see page 13.
- Progressive scan does not work with the analog video connections (yellow VIDEO OUT jack).

Rear of TV

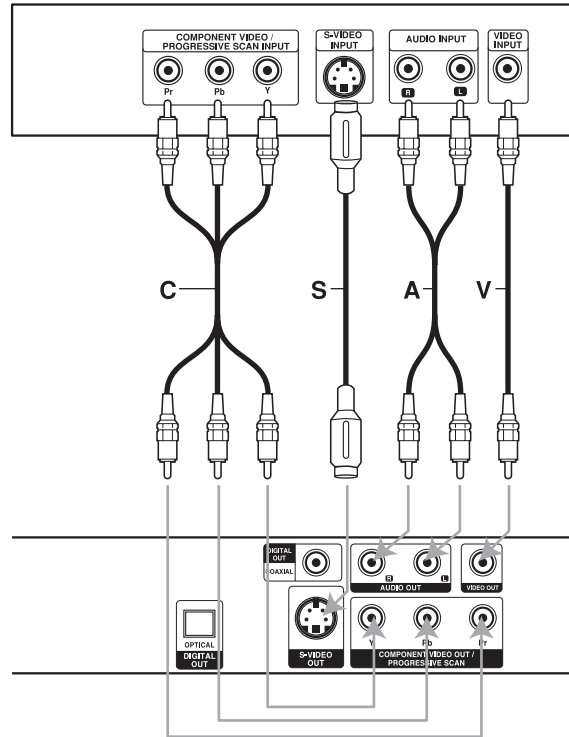

Rear of DVD player

Preparation

CONNECTIONS

CONNECTING TO OPTIONAL EQUIPMENT

Connecting to an amplifier equipped with two channel analog stereo or Dolby Pro Logic II / Pro Logic

Connect the Left and Right AUDIO OUT connectors on the DVD Player to the audio left and right in connectors on your amplifier, receiver, or stereo system, using the audio cables (A).

Connecting to an amplifier equipped with two channel digital stereo (PCM) or to an Audio / Video receiver equipped with a multi-channel decoder (Dolby Digital™, MPEG 2, or DTS)

- 1 Connect one of the DVD Player's DIGITAL AUDIO OUT connectors (OPTICAL (O) or COAXIAL (X)) to the corresponding in jack on your amplifier. Use an optional digital (optical (O) or coaxial (X)) audio cable.
- 2 You will need to activate the player's digital output. (See "Digital Audio Output" on page 14).

DIGITAL MULTI-CHANNEL SOUND

A digital multi-channel connection provides the best sound quality. For this you need a multi-channel Audio/Video receiver that supports one or more of the audio formats supported by your DVD Player (MPEG 2, Dolby Digital and DTS). Check the receiver manual and the logos on the front of the receiver.

CAUTION

Due to the DTS Licensing agreement, the digital output will be in DTS digital out when DTS audio stream is selected.

Rear of DVD player

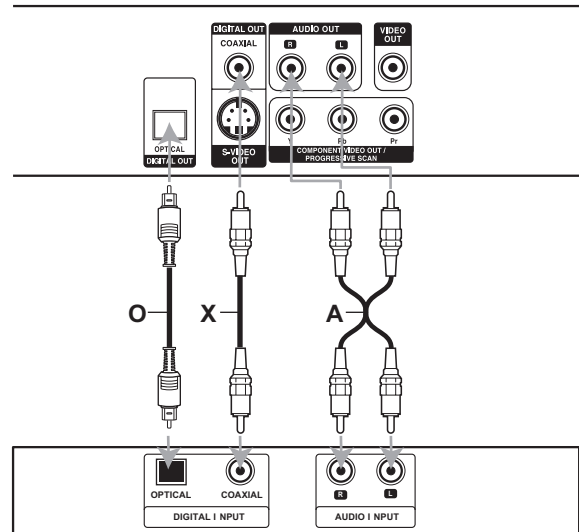

Amplifier (Receiver)

NOTES

- If the audio format of the digital output does not match the capabilities of your receiver, the receiver will produce a strong, distorted sound or no sound at all.
- Six Channel Digital Surround Sound via digital connection can only be obtained if your receiver is equipped with a Digital Multi-channel decoder.
- To see the audio format of the current DVD in the onscreen display, press AUDIO.

GENERAL EXPLANATION

This manual gives basic instructions for operating the DVD Player. Some DVDs require specific operation or allow only limited operation during playback. When this occurs, the symbol appears on the TV screen, indicating that the operation is not permitted by the DVD Player or is not available on the disc.









ON-SCREEN DISPLAY

General playback status can be displayed on the TV screen. Some items can be changed on the menu.

ON-SCREEN DISPLAY OPERATION

- 1 Press DISP during playback.
- 2 Press ▲/▼ to select an item. The selected item will be highlighted.
- 3 Press ◀/▶ to change the setting of an item. The number buttons can be also be used for setting numbers (e.g., title number). For some functions, press ENTER to execute the setting.







TEMPORARY FEEDBACK FIELD ICONS

-  TITLE Repeat Title
-  CHAPT Repeat Chapter
-  GROUP Repeat Group (DVD audio discs only)
-  TRACK Repeat Track
(non-PBC Video CDs and DVD audio discs only)
-  ALL Repeat All Tracks (non-PBC Video CDs only)
-  A B Repeat A-B
-  OFF Repeat Off
-  ■ ■ ■ Resume play from this point
-  ⓧ Action prohibited or not available

NOTES

- Some discs may not provide all of the features on the on-screen display example shown below.
- If no button is pressed for 10 seconds, the on-screen display disappears.

DVD-V





| Items | | Function (Press ▲/▼ to select desired item) | Selection Method |
|--|--|--|------------------------|
| Title Number |  1 / 3 | Shows the current title number and total number of titles, and skips to the desired title number. | ◀/▶, or Numbers, ENTER |
| Chapter Number |  1 / 12 | Shows the current chapter number and total number of chapters, and skips to the desired chapter number. | ◀/▶, or Numbers, ENTER |
| Time search |  0:20:09 | Shows the elapsed playing time, and searches the point by the elapsed time directly. | Numbers, ENTER |
| Audio language and Digital Audio Output mode |  1 ENG □□□ 5.1 CH | Shows the current audio soundtrack language, encoding method, and channel number, and changes the setting. | ◀/▶, or AUDEO |
| Subtitle language |  ABC OFF | Shows the current subtitles language, and changes the setting. | ◀/▶, or SUBTITLE |
| Angle |  1 / 1 | Shows the current angle number and total number of angles, and changes the angle number. | ◀/▶, or ANGLE |
| Sound |  NORM. | Shows the current sound mode, and changes the setting. | ◀/▶ |

Preparation

BEFORE OPERATION

VCD 2.0

VCD 1.1

| Items | | Function (Press ▲/▼ to select desired item) | Selection Method |
|---------------|--|---|------------------------|
| Track Number |  1/3 | Shows the current track number, total number of tracks and PBC On mode, and skip to the desired track number. | ◀/▶, or Numbers, ENTER |
| Time |  1/12 | Shows the elapsed playing time (Display only) | - - - |
| Audio Channel |  0:20:09 | Shows the audio channel, and changes the audio channel. | ◀/▶, or AUDEO |
| Sound |  1 ENG □□□ 5.1 CH | Shows the current sound mode, and changes the setting. | ◀/▶ |

INITIAL SETTINGS

You can set your own Personal Preferences on the player.

Initial Settings General Operation

- 1 Press SETUP. The setup menu appears.
- 2 Press ▲/▼ to select the desired item. The screen will show the current setting for the selected item, as well as alternate setting(s).
- 3 While the desired item is selected, press ►, then ▲/▼ to select the desired setting.
- 4 Press ENTER to confirm your selection. Some items require additional steps.
- 5 Press SETUP, RTN, or PLAY to exit the setup menu.

LANGUAGE

DISC LANGUAGE DVD-V

Select a language for the disc's Menu, Audio, and Subtitle.

Original: The original language set for the disc is selected.

Other: To select another language, press number buttons to enter the corresponding 4-digit number according to the language code list on page 27. If you enter the wrong language code, press CLEAR.

MENU LANGUAGE



Select a language for the setup menu. This is the menu you see when you press SETUP.

DISPLAY

TV ASPECT DVD-V

4:3 Select when a standard 4:3 TV is connected. Displays theatrical images with masking bars above and below the picture (**Display Mode: Widescreen**)

16:9 Select when a 16:9 wide TV is connected.

Display Mode DVD-V

Panscan: Select when a conventional TV set is connected. The video material formatted in the Pan & Scan style is played back in that style (Both sides of the picture are cut off).

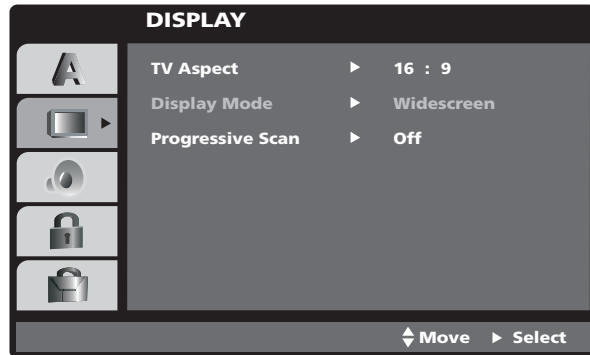

PROGRESSIVE SCAN DVD-V

Progressive Scan Video provides the highest quality pictures with less flickering. If you are using the COMPONENT VIDEO OUT/ PROGRESSIVE

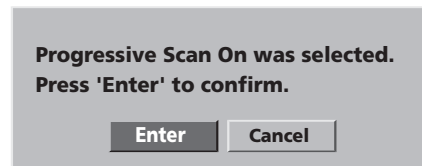
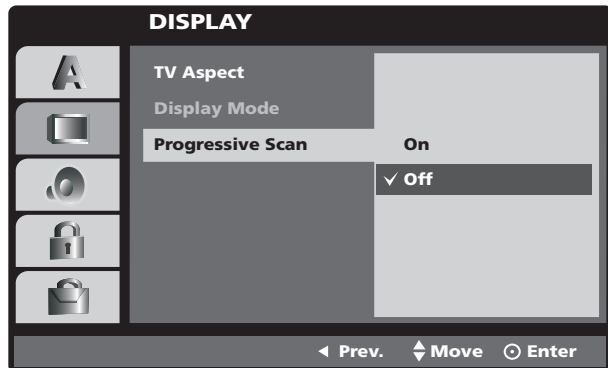

SCAN connectors, but are connecting the DVD Player to a standard (analog) television, set Progressive Scan to Off. If you are using the Component Video connectors for connection to a TV or monitor that is compatible with a progressive scan signal, set Progressive Scan to On.

CAUTION

Once the setting for progressive scan output is entered, an image will only be visible on a progressive scan compatible TV or monitor. If you set Progressive Scan to On in error, you must reset the unit. Press STOP to stop any disc that is playing. Next, press STOP again and hold it for five seconds before releasing it. The video output will be restored to the standard setting, and a picture will once again be visible on a conventional analog TV or monitor.

Preparation

BEFORE OPERATION

AUDIO

DIGITAL AUDIO OUTPUT

Each DVD disc has a variety of audio output options. Set the player's Digital Audio Output according to the type of audio system you use.

DOLBY DIGITAL Bitstream/PCM: Select "DOLBY DIGITAL/PCM" if you connected the DVD Player's DIGITAL OUT jack to a Dolby Digital decoder (or an amplifier or other equipment with a Dolby Digital decoder).

DTS Bitstream/Off: Select "Stream/Off" if you connected the DVD Player's DIGITAL OUT jack to an amplifier or other equipment with a DTS decoder.

MPEG Bitstream/PCM: Select "Stream/PCM" if you connected the DVD Player's DIGITAL OUT jack to an amplifier or other equipment with a MPEG decoder. Select when connected to a 2-channel digital stereo amplifier. The DVD player outputs sounds in the PCM 2channel format when you play a DVD video disc recorded on the Dolby Digital, MPEG1, or MPEG2 recording system.

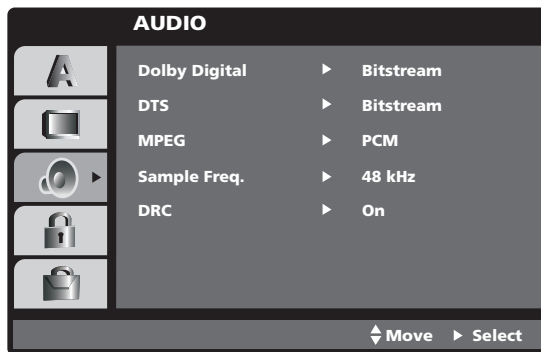

SAMPLE FREQUENCY

To change the Sample Frequency setting, first select the desired Digital Audio Output as indicated as above.

If your receiver or amplifier is NOT capable of handling 96 KHz signals, select 48 KHz. When this choice is made, this unit will automatically convert any 96 KHz signals to 48 KHz so your system can decode them. If your receiver or amplifier is capable of handling 96 KHz signals, select 96 KHz. When this choice is made, this unit will pass each type of signal through without any further processing.

DYNAMIC RANGE COMPRESSION (DRC)

With the DVD format, you can hear a program's soundtrack in the most accurate and realistic presentation possible, thanks to digital audio technology. However, you may wish to compress the dynamic range of the audio output (the difference between the loudest sounds and the quietest ones). Then, you may listen to a movie at a lower volume without losing clarity of sound. Set DRC to On for this effect.

OTHERS

The DRC, PBC and Auto Play settings can be changed.

- Press ▲/▼ to select the desired item and press ENTER. The setting of the selected item is changed between On and Off.

**PBC**

Set Playback Control (PBC) to On or Off.

On: Video CDs with PBC are played according to the PBC.

Off: Video CDs with PBC are played the same way as Audio CDs.

AUTO PLAY DVD-V

You can set up the DVD Player so a DVD disc automatically starts playing whenever the DVD is inserted. If Auto Play mode is set to On, the T514 DVD player will search for the longest title playback time and then play back the title automatically.

On: Auto Play function is activated.

Off: Auto Play function is not activated.

NOTE

- The Auto Play function may not work for some DVDs.

B.L.E. (BLACK LEVEL EXPANSION)

On: Expanded grey scale. (0 Black Level)

Off: Standard grey scale. (7.5 Black Level)

LOCK (PARENTAL CONTROL)**RATING** DVD-V

Movies on DVDs may contain scenes not suitable for children. Therefore, discs may contain Parental Control information that applies to the complete disc or to certain scenes on the disc. These scenes are rated from 1 to 8, and alternatively, more suitable scenes are available for selection on some discs. Ratings are country-dependent. The Parental Control feature allows you to prevent discs from being played by your children or to have certain discs played with alternative scenes.

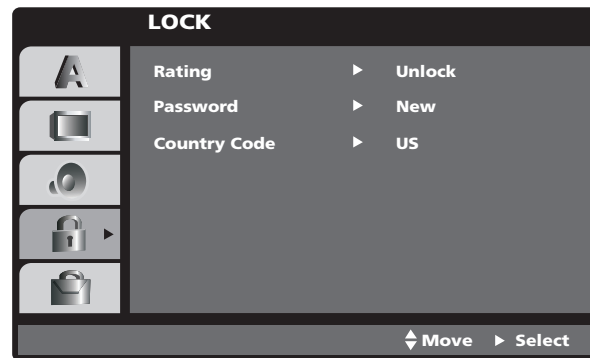

- 1 Select "Rating" on the Setup menu using the ▲/▼ buttons.
- 2 While "Rating" is selected, press ►.
- 3 **When you have not yet entered a password;**
Enter a 4-digit password using the numbered buttons to create a personal 4-digit security password, and then press ENTER. Enter the 4-digit password again and press ENTER to verify.
When you have already entered a password;
Enter a 4-digit password using the numbered buttons to confirm the personal 4-digit security password, and then press ENTER. If you make a mistake before pressing ENTER, press CLEAR and enter 4-digit security password again.
- 4 **Select a rating from 1 to 8 using the ▲/▼ buttons. Eight (8) has the least playback restrictions. One (1) has the most playback restrictions.**
Unlock: If you select Unlock, Parental Control is not active. The disc will play in full.
Ratings 1 to 8. Some discs contain scenes not suitable for children. If you set a rating for the player, all disc scenes with the same rating or lower will be played. Higher rated scenes will not be played unless an alternative scene is available on the disc.
The alternative must have the same rating or a lower one. If no suitable alternative is found, playback will stop. You must enter the 4-digit password or change the rating level in order to play the disc.
- 5 **Press ENTER to confirm your rating selection, and then press SETUP to exit the menu.**

Preparation

BEFORE OPERATION

COUNTRY CODE DVD-V

Enter the code of a country/area whose standards were used to rate the DVD video disc, referring to the list (See "Country Code List", page 28.)

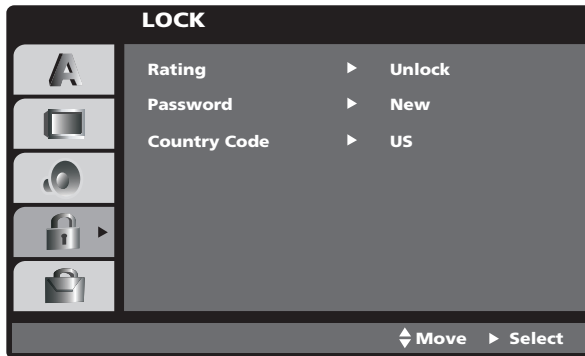

- 1 Select Country Code using the ▲/▼ buttons on the setup menu.
- 2 While Country Code is selected, press ►.
- 3 Follow step number "3" of "Rating" on left side of this page.
- 4 Select the first character using the ▲/▼ buttons.
- 5 Shift the cursor using ► button and select the second character using ▲/▼ buttons.
- 6 Press ENTER to confirm your country code selection, then press SETUP to exit the menu.

NOTE

Confirmation of the 4-digit password is necessary when the code is changed (see "Changing the 4-digit code" below).

CHANGING THE 4-DIGIT CODE

- 1 Follow Steps 1-2 as shown above to the left (Rating).
- 2 Enter the old code, and then press ENTER.
- 3 Select Change using ▲/▼ buttons then press ENTER.
- 4 Enter the new 4-digit code, and then press ENTER.
- 5 Enter exactly the same code a second time and verify by pressing ENTER.
- 6 Press SETUP to exit the menu.

IF YOU FORGET YOUR 4-DIGIT CODE

If you forget your password, to clear the current password, follow the procedure below:

- 1 Press SETUP to display the setup menu.
- 2 Use the Number buttons to enter the 6-digit number "210499". The 4-digit password is cleared. "P CLr" appears on the T514's front display for a moment.
- 3 Enter a new code as shown under "Rating"

PLAYING A DVD AND VIDEO CD

PLAYBACK SETUP DVD-V VCD 2.0 VCD 1.1

- Turn on the TV and select the video input source connected to the DVD player.
- Audio system: Turn on the audio system and select the input source connected to the DVD player.

- 1 Press **OPEN/CLOSE** to open the disc tray.
- 2 Load your chosen disc in the tray, with the playback side down.
- 3 Press **OPEN/CLOSE** to close the tray. **READING** appears on the TV screen, and playback starts automatically. If playback does not start, press **PLAY**. In some cases, the disc menu might appear instead.

IF A MENU SCREEN IS DISPLAYED

The menu screen may be displayed first after loading a DVD or Video CD which offer a menu.

DVD-V

Use the **▲/▼/◀/▶** buttons to select the title/chapter you want to view, then press **ENTER** to start playback. Press **TITLE** or **MENU** to return to the menu screen.

VCD 2.0

- Use the number buttons to select the track you want to view. Press **RTN** to return to the menu screen.
- Menu setting and the exact operating procedures for using the menu may differ depending on the disc. Follow the instructions on the each menu screen. You also may set **PBC** to **Off** under setup. See page 15.

NOTES

- If **Parental Control** is set and the disc is not within the **Rating** settings (not authorized), the 4-digit code must be entered and/or the disc must be authorized (see "Parental Control").
- DVDs may have a region code. Your player will not play discs that have a region code different from your player. The region code for this player is 1.

GENERAL FEATURES

NOTE

Unless stated otherwise, all operations described use the remote control. Some features may also be available on the **Setup** menu.

MOVING TO ANOTHER TITLE / GROUP DVD-V

When a disc has more than one title/group, you can move to another title/group as follows:

- Press **DISP**, then press the appropriate numbered button (0-9) to select a title/group number.

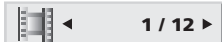

MOVING TO ANOTHER CHAPTER / TRACK

DVD-V VCD 1.1

When a title on a disc has more than one chapter or a disc has more than one track, you can move to another chapter/track as follows:

- Press **SKIP** **◀◀** or **▶▶** briefly during playback to select the next chapter/track or to return to the beginning of the current chapter/track.
- Press **◀◀** twice briefly to step back to the previous chapter/track.
- To go directly to any chapter during DVD playback, press **DISP**. Then, press **▲/▼** to select the chapter/track icon. Then, enter the chapter/track number using the numbered buttons (0-9).



NOTE

For two-digit numbers, press the numbered buttons (0-9) in rapid succession.

SEARCH DVD-V VCD 2.0 VCD 1.1

- 1 Press and hold **SCAN** **◀◀** or **▶▶** for about two seconds during playback. The player will now go into **SEARCH** mode.
- 2 Press and hold **SCAN** **◀◀** or **▶▶** repeatedly to select the required speed: **◀◀ X2**, **◀◀ X4**, **◀◀ X16**, **◀◀ X100** (backward) or **▶▶ X2**, **▶▶ X4**, **▶▶ X16**, **▶▶ X100** (forward). With a Video CD, the Search speed changes: **◀◀ X2**, **◀◀ X4**, **◀◀ X8**, (backward) or **▶▶ X2**, **▶▶ X4**, **▶▶ X8**, (forward).
- 3 To exit **SEARCH** mode, press **PLAY**.

NOTE

When using a DVD audio disc that includes pictures, this operation may be permitted in some picture segments.

PAUSE DVD-V VCD 2.0 VCD 1.1

- 1 Press **PAUSE/STEP** during playback.
- 2 To return to playback, press **PLAY**.

STILL PICTURE AND FRAME-BY-FRAME PLAYBACK

DVD-V VCD 2.0 VCD 1.1

- 1 Press **PAUSE/STEP** during playback. The player will now go into **PAUSE** mode.
- 2 You can advance the picture frame-by-frame by pressing **PAUSE/STEP** repeatedly on the remote control.

NOTE

When using a DVD audio disc that includes pictures, this operation may be permitted in some picture segments.

Operation

OPERATION WITH DVD AND VIDEO CD

SLOW MOTION DVD-V VCD 2.0 VCD 1.1

- 1 Press SLOW ◀◀ or ▶▶ during playback. The player will enter SLOW mode.
- 2 Use the SLOW ◀◀ or ▶▶ to select the required speed: ◀◀ 1/16, ◀◀ 1/8, ◀◀ 1/4 or ◀◀ 1/2 (backward), or ▶▶ 1/16, ▶▶ 1/8, ▶▶ 1/4 or ▶▶ 1/2 (forward).
- 3 To exit slow motion mode, press PLAY.

NOTE

- Slow motion playback in reverse is not applicable for Video CD.
- When using a DVD audio disc that includes pictures, this operation may be permitted in some picture segments.

RANDOM VCD 2.0 VCD 1.1

- 1 Press RANDOM during playback or in stop mode. The unit automatically begins Random Playback and "RANDOM" appears on the display window.
- 2 To return to normal playback, press RANDOM until "RANDOM" disappears on the display window.

TIPS

By pressing SKIP ▶▶ during Random playback, the unit selects another title (track) and resumes Random playback.

NOTE

- This function only works with video CD without PBC.
- On a Video CD with PBC, you must set PBC to Off in the setup menu to use the Random function. See page 15.

REPEAT A-B DVD-V VCD 2.0 VCD 1.1

To repeat a sequence in a title or group:

- 1 Press RPT A-B at your chosen starting point. "A *" appears briefly on the TV screen.
- 2 Press RPT A-B again at your chosen end point. "A B" appears briefly on the TV screen, and the repeat sequence begins ("A B" appears the display window).
- 3 To cancel the sequence, press RPT A-B.



REPEAT DVD-V VCD 2.0 VCD 1.1

DVD Video Discs - Repeat Chapter/Title/Off

- 1 To repeat the currently playing chapter, press REPEAT. The Repeat Chapter icon appears on the TV screen.
- 2 To repeat the title currently playing, press REPEAT a second time. The Repeat Title icon appears on the TV screen.
- 3 To exit Repeat mode, press REPEAT a third time. The Repeat Off icon appears on the TV screen.



DVD Audio Discs - Repeat Track/Group/Off

- 1 To repeat the currently playing track, press REPEAT. The Repeat Track icon appears on the TV screen.
- 2 To repeat the group currently playing, press REPEAT a second time. The Repeat Group icon appears on the TV screen.
- 3 To exit Repeat mode, press REPEAT a third time. The Repeat Off icon appears on the TV screen.

Video CDs - Repeat Track/All/Off

- 1 To repeat the track currently playing, press REPEAT. The Repeat Track icon appears on the TV screen.
- 2 To repeat the disc currently playing, press REPEAT a second time. The Repeat All icon appears on the TV screen.
- 3 To exit Repeat mode, press REPEAT a third time. The Repeat Off icon appears on the TV screen.

NOTE

On a Video CD with PBC, you must set PBC to Off on the setup menu to use the Repeat function. See page 15.

TIME SEARCH DVD-V

The Time Search function allows you to start playing at any chosen time on the disc.

- 1 Press DISP during playback. The on-screen display appears on the screen. The Time Search box shows the elapsed playing time of the current disc.
- 2 Within 10 seconds, press ▲/▼ to select the Time Search icon in the on-screen display. The "⏮:⏭" appears in the Time Search box.
- 3 Within 10 seconds, use the number buttons to enter the required start time. Enter hours, minutes, and seconds from left to right in the box. If you enter the wrong numbers, press CLEAR to remove the numbers you entered. Then enter the correct numbers.
- 4 Within 10 seconds, press ENTER to confirm the start time. Playback starts from the selected time on the disc. If you enter an invalid time, playback will continue from the current point.



3D SURROUND DVD-V VCD 2.0 VCD 1.1

This unit can produce a 3D Surround effect, which simulates multi-channel audio playback from two conventional stereo speakers, instead of the five or more speakers normally required to listen to multichannel audio from a home theater system.

- 1 Press DISP during playback.
- 2 Use ▲/▼ to select the sound option. The sound option will be highlighted.
- 3 Use ◀/▶ to select "3D SUR". To turn off the 3D Surround effect, select "NORM".



ZOOM DVD-V VCD 2.0 VCD 1.1

The Zoom function allows you to enlarge the video image and to move through the enlarged image.

- 1 Press ZOOM during playback or still playback to activate the Zoom function. If you press ZOOM repeatedly, the magnification level increases up to six steps.
- 2 Use the ▲/▼/◀/▶ buttons to move through the zoomed picture.
- 3 Press CLEAR to resume normal playback or return to the paused image.

NOTE

The zoom function may not work for some DVDs.

MARKER SEARCH DVD-V VCD 2.0 VCD 1.1

You can start playback from a memorized point. Up to nine points can be memorized. To enter a mark, follow these steps.

- 1 During disc playback, press MARKER when playback reaches the spot that you want to memorize. The Marker icon will appear on the TV screen briefly.
- 2 Repeat step 1 to enter up to nine Marker points on a disc.



To Recall a Marked Scene

- 1 During disc playback, press SEARCH. The MARKER SEARCH menu will appear on the screen.
- 2 Within 10 seconds, press ◀/▶ to select a Marker number that you want to recall.
- 3 Press ENTER. Playback will start from the marked scene.
- 4 To remove the MARKER SEARCH menu, press SEARCH.

To clear a Marked Scene

- 1 During disc playback, press SEARCH. The MARKER SEARCH menu will appear on the screen.
- 2 Press ◀/▶ to select the Marker number that you want to erase.
- 3 Press CLEAR. The Marker number will be erased from the list.
- 4 Repeat steps 2 and 3 to erase additional Marker numbers.
- 5 To remove the MARKER SEARCH menu, press SEARCH.

SPECIAL DVD FEATURES

MENUS DVD-V

DVDs may offer menus that allow you to access special features. To use the disc menu, press MENU. Then, press the appropriate number button to select an option. Or, use the ▲/▼/◀/▶ buttons to highlight your selection, then press ENTER.

TITLE MENU DVD-V

- 1 Press TITLE. If the current title has a menu, the menu will appear on the screen. Otherwise, the disc menu may appear.
- 2 The menu can list camera angles, spoken language and subtitle options, and chapters for the title.
- 3 To remove the title menu, press TITLE again.

DISC MENU DVD-V

- 1 Press MENU. The disc menu is displayed.
- 2 To remove the disc menu, press MENU again.

CAMERA ANGLE DVD-V

If the disc contains scenes recorded at different camera angles, you can change to a different camera angle during playback.

- Press ANGLE repeatedly during playback to select a desired angle. The number of the current angle appears on the display.



CHANGING THE AUDIO LANGUAGE DVD-V

Press AUDIO repeatedly during playback to hear a different audio language or audio track.



CHANGING THE AUDIO CHANNEL VCD 2.0 VCD 1.1

Press AUDIO repeatedly during playback to hear a different audio channel (STER., LEFT or RIGHT).

SUBTITLES DVD-V

Press SUBTITLE repeatedly during playback to see the different subtitle languages.



NOTE

If "S" appears, the feature is not available on the disc.

Operation

OPERATION WITH DVD AND VIDEO CD

PLAYING A DVD-VR FORMAT DISC

This unit will play DVD+R/RW discs recorded using the DVD-Video Recording format that has been finalized using a DVD-recorder.

- 1 Insert a disc and close the tray. The menu for the DVD-VR format appears on the TV screen.
- 2 Press ▲/▼ to select the track and then press PLAY or ENTER and playback starts.

NOTE:

Unfinalized DVD+R/RW discs cannot be played in this DVD-player. Some DVD-VR discs are made with CPRM data by personal DVD recorders. This DVD-player may not support this disc format created on some DVD recorders, and will display "CHECK DISC".

What is "CPRM"?

CPRM is a copy protection, using encryption technology, so that to only allow the recording of "copy once" broadcast programs. CPRM is an acronym for Content Protection for Recorded Media.

This player is CPRM compatible, which means you can play "copy-once" broadcast programs. CPRM recordings can only be made on DVD+RW formatted in VR mode, and CPRM recordings can only be played on players that are specifically compatible with CPRM.

OPERATION WITH AUDIO CD AND MP3 / WMA DISC

PLAYING AN AUDIO CD AND MP3 / WMA DISC

CD MP3 WMA

The DVD Player can play MP3/WMA formatted recordings on CD-ROM, CD-R or CD-RW discs. Before playing MP3/WMA recordings, read the notes on MP3/WMA Recordings on right.

1 Insert a disc and close the tray.

Audio CD; Audio CD menu appears on the TV screen go to step 4.

2 Press ▲/▼ to select a folder, and ENTER.

A list of files in the folder appears.

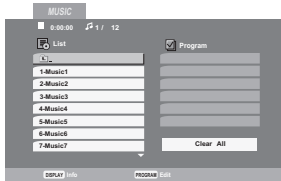

3 Press ▲/▼ to select a track then press PLAY or ENTER.

Playback starts. During playback, the current track's elapsed playing time will appear on the display window and menu. Playback will stop at the end of the disc.

Press TITLE to move to the next page.

Press MENU to move to the previous page.

Audio CD menu

MP3/WMA menu

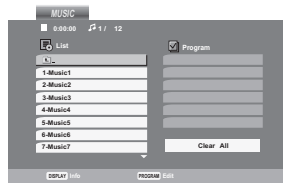

TIP

If you are in a file list and want to return to the Folder list, use the ▲/▼ to highlight and press ENTER to return to the previous menu screen.

4 To stop playback at any other time, press STOP.

ID3 TAG

- When playing a file containing information such as track titles, you can see the information by pressing the remote control DISPLAY button. The following may be available displays; Title, Artist, Album, Year, and Comment.
- If there is no information, "NO ID3 TAG" will appear on the OSD.

TIP:

- On a CD with MP3/WMA, and JPEG files, you can switch between MUSIC and PHOTO menus. By pressing the TITLE button on the remote control, a pop-up icon displaying MUSIC, or PHOTO will appear above the menu

NOTES ON MP3/WMA RECORDINGS

ABOUT MP3

- An MP3 file is audio data compressed by using the MPEG1 audio layer-3 file-coding scheme. We call files that have the ".mp3" file extension "MP3 files".
- The player can not read an MP3 file that has a file extension other than ".mp3".

ABOUT WMA (WINDOW MEDIA AUDIO)

- An WMA file is a Microsoft audio compression technology.
- WMA (Windows Media Audio) offers double the audio compression of the MP3 format.

MP3 / WMA Disc compatibility with this player is limited as follows:

- 1 Sampling Frequency / only at 44.1 kHz (MP3), 22.05 - 44.1 kHz (WMA)
- 2 Bit rate / within 32 - 320 kbps (MP3), 32 - 196 kbps (WMA)
- 3 CD-R physical format should be "ISO 9660"
- 4 If you record MP3/WMA files using the software which cannot create a FILE SYSTEM, for example "Direct-CD" etc., it is impossible to playback MP3/WMA files. We recommend that you use "Easy-CD Creator", which creates an ISO9660 file system.
- 5 A single session disc requires MP3/WMA files in the first track. If there is no MP3/WMA file in the 1st track, it cannot playback MP3/WMA files. If you wish to playback MP3/WMA files, format all the data in the disc or use a new one.
- 6 File names should be named using 8 letters or less and must incorporate ".mp3" or ".wma" extension e.g. "*****.MP3" or "*****.WMA".
- 7 Do not use special letters such as / : \ * ? " < > " etc.
- 8 Total number of files on the disc should be less than 650. This DVD player requires discs/recordings to meet certain technical standards in order to achieve optimal playback quality. Pre-recorded DVDs are automatically set to these standards. There are many different types of recordable disc formats (including CD-R containing MP3 or WMA files) that require certain pre-existing conditions (see above) to insure compatible playback.

Customers should also note that permission is required in order to download MP3/WMA files and music from the Internet. NAD Electronics International has no right to grant such permission. Permission should always be sought from the copyright owner.

PAUSE CD MP3 WMA

- 1 Press PAUSE/STEP during playback.
- 2 To return to playback, press PLAY or press PAUSE/STEP again.

MOVING TO ANOTHER TRACK CD MP3 WMA

- Press SKIP or briefly during playback to go to the next track or to return to the beginning of the current track.
- Press SKIP twice briefly to step back to the previous track.
- In case of audio CD, to go directly to any track, enter the track number using the numbered buttons (0-9) during playback.

REPEAT TRACK / ALL / OFF CD MP3 WMA

- 1 To repeat the track currently playing, press REPEAT. The Repeat icon and "TRACK" appears on the menu screen.
- 2 To repeat all tracks on a disc, press REPEAT a second time. The Repeat icon and "ALL" appears on the menu screen.
- 3 To cancel Repeat mode, press REPEAT a third time. The Repeat icon and "OFF" appears on the menu screen.

Operation

OPERATION WITH AUDIO CD AND MP3 / WMA / JPEG DISC

SEARCH CD MP3 WMA

- 1 Press and hold SCAN ◀◀ or ▶▶ during playback. The player will now go into SEARCH mode.
- 2 Press and hold SCAN ◀◀ or ▶▶ repeatedly to select the required speed: ◀◀X2, ◀◀X4, ◀◀X8 (backward) or ▶▶X2, ▶▶X4, ▶▶X8 (forward). Search speed and direction are indicated on the menu screen.
- 3 To exit SEARCH mode, press PLAY.

RANDOM CD MP3 WMA

- 1 Press RANDOM during playback or when playback is stopped. The unit automatically begins Random Playback and RANDOM or "RAND." appears on the display window and menu screen.
- 2 To return to normal playback, press RANDOM repeatedly until RANDOM or "RAND." disappears on the display window and menu screen.

REPEAT A-B CD

To repeat a sequence:

- 1 During disc playback, press RPT A-B at your chosen starting point. The Repeat icon and "A *" appears on the menu screen.
- 2 Press RPT A-B again at your chosen end point. The Repeat icon and "A B" appears on the menu screen, and the sequence begins to play repeatedly.
- 3 To exit the sequence and return to normal play, press RPT A-B again. The Repeat icon and "OFF" appears on the menu screen.

3D SURROUND CD

This unit can produce a 3D Surround effect, which simulates multi-channel audio playback from two conventional stereo speakers, instead of the five or more speakers normally required to listen to multichannel audio from a home theater system.

- 1 Press DISP during playback.
- 2 Use ◀/▶ to select the sound option. The sound option will be highlighted.
- 3 Use ▲/▼ to select "3D SUR". To turn off the 3D Surround effect, select "NORM".

CHANGING THE AUDIO CHANNEL CD

Press AUDIO repeatedly during playback to hear a different audio channel (STER., LEFT, or RIGHT).

VIEWING A JPEG DISC JPEG

This DVD Player can play discs with JPEG files and Kodak picture CD. Before playing JPEG recordings, read the notes on JPEG Recordings on the right.

1 Press ▲/▼ to select the JPEG then press ENTER.

The JPEG menu appears on the TV screen.

2 Press ▲/▼ to select a folder, and ENTER.

A list of files in the folder appears. Press RTN to move to the MP3/WMA-JPEG choice menu.

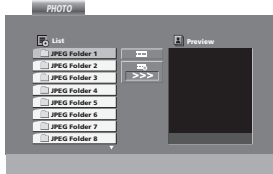

TIP

If you are in a file list and want to return to the Folder list, use the ▲/▼ buttons on the remote to highlight "◀" and press ENTER to return to the previous menu screen.

3 If you want to view a particular file, press ▲/▼ to highlight a file and press ENTER or PLAY.

Viewing of the file starts. During viewing a file, press RTN to move to the previous menu (JPEG menu).

Press TITLE to move to the next page.

Press MENU to move to the previous page.

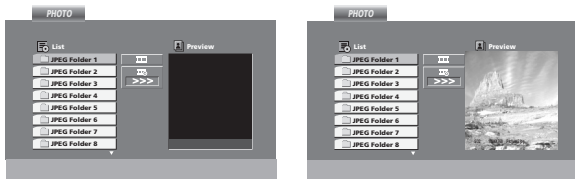

TIP

There are three viewing Slide Speed options: Fast, Normal, Slow, and Off. Press ◀/▶ to highlight the Slide Speed then press ▲/▼ to select the option you want to use, and press ENTER.

4 To stop viewing at any other time, press STOP.

The JPEG menu appears.

TIP:

- Press the MENU on the remote to move to the next page
- There are three Slide Speed options (fast, normal, and slow) folder slide show icon, ▶▶▶ (fast), ▶▶ (normal), and ▶ (slow). With the remote, use the ▲/▼/◀/▶ buttons to highlight the Speed. Then use the ◀/▶ to select the option you want to use, and then press ENTER.

SLIDE SHOW

Use the ▲/▼/◀/▶ buttons on the remote to highlight the (Slide Show) then press ENTER.

MOVING TO ANOTHER FILE

Press SKIP ◀◀ or ▶▶ once during viewing a picture to advance to the next file or to the previous file.

STILL PICTURE

1 Press PAUSE/STEP during slide show. The player will now go into PAUSE mode.

2 To return to the slide show, press PLAY or press PAUSE/STEP again.

TO FLIP THE PICTURE

Press ▲/▼ during showing a picture to flip the picture horizontally or a vertically.

TO ROTATE PICTURE

Press ◀/▶ during showing a picture to rotate the picture clockwise or counter clockwise.

NOTES ON JPEG RECORDINGS

- Depending upon the size and number of the JPEG files, it could take a long time for the DVD player to read the disc's contents. If you don't see an onscreen display after several minutes, some of the files are too big - reduce the resolution of the JPEG files to less than 2 mega pixels and burn another disc.
- Total number of files and folders on the disc should be less than 650.
- Some disc may be incompatible due to different recording format or condition of disc.
- When you are using software such as "Easy CD Creator" to burn the jpeg files into the CD-R, ensure that all the selected files have the ".jpg" extensions when copying into the CD layout.
- If the files have ".jpe" or ".jpeg" extensions, please rename them as ".jpg" files.
- File names without ".jpg" extension will not be able to be read by this DVD player. Even though the files are shown as JPEG image files in windows explorer.

Operation

PROGRAMMED PLAYBACK VCD 2.0 VCD 1.1 CD MP3 WMA

PROGRAMMED PLAYBACK WITH AUDIO CD AND MP3/WMA DISC

The Program function enables you to store your favorite tracks from any disc in the player memory. Program can contain 30 tracks.

- 1 Press **PROGRAM** during playback or in the stop mode to enter the Program Edit mode. The mark will appear to the right of the word Program on the right side of the menu screen.

NOTE

Press **PROGRAM** to exit the Program Edit mode; the  mark will disappear.

- 2 Select a track, and then press **ENTER** to place the selected track on the Program list.
- 3 Repeat step 2 to place additional tracks on the Program list.

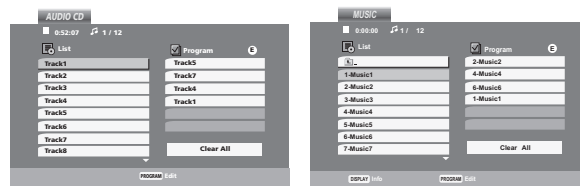

Audio CD menu

MP3/WMA menu

- 4 Press **▶**. The programmed track you selected last is highlighted on the program list.
- 5 Press **▲/▼** to select the track you want to start playing. Press **TITLE** to move to the next page. Press **MENU** to move to the previous page.
- 6 Press **PLAY** to start. Playback begins in the order in which you programmed the tracks and "PROG." appears on the menu screen. Playback stops after all of the tracks on the Program list have played once.
- 7 To resume normal playback from programmed playback, select a track of CD (or MP3/WMA) list and then press **ENTER**. "PROG." indicator disappears on the menu screen.

PROGRAMMED PLAYBACK WITH VIDEO CD NOTE

On a Video CD with PBC, you must set PBC to Off on the setup menu to use the Program function. See page 15

- 1 Insert Video CD and close the tray.
- 2 Press **PROGRAM** while playback is stopped. The VCD Program menu will appear.

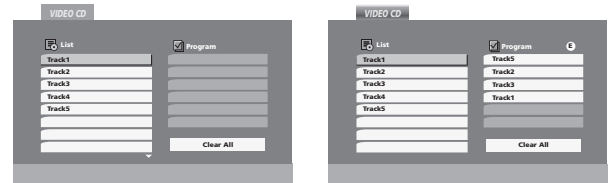

NOTE

Press **RTN** or **PROGRAM** to exit the Program menu.

- 3 Follow steps 2-6 of "Programmed Playback with Audio CD and MP3/WMA disc" on left.
- 4 To resume normal playback from programmed playback, press **PROGRAM**. "PROG." indicator disappears in the display window.

REPEAT PROGRAMMED TRACKS

- To repeat the track currently playing, press **REPEAT**. The Repeat icon and "TRACK" appears on the menu screen.
- To repeat all tracks on the program list, press **REPEAT** a second time. The Repeat icon and "ALL" appears on the menu screen.
- To cancel Repeat mode, press **REPEAT** a third time. The Repeat icon and "OFF" appears on the menu screen.

ERASING A TRACK FROM PROGRAM LIST

- 1 Press **PROGRAM** during playback (Audio CD and MP3/WMA disc only) or in the stop mode to enter the Program Edit mode. The  mark will appear.
- 2 Press **▶** to move to the Program list.
- 3 Use **▲/▼** to select the track that you wish to erase from the Program list.
- 4 Press **CLEAR**. The track will be erased from the Program list.

ERASING THE COMPLETE PROGRAM LIST

- 1 Follow steps 1-2 of "Erasing a Track from Program List" as above.
- 2 Use **▲/▼** to select "Clear All", and then press **ENTER**. The complete Program for the disc will be erased. The programs are also cleared when the disc is removed.

LAST CONDITION MEMORY DVD-V VCD 2.0 VCD 1.1

This player memorizes the user settings for the last disc that you have viewed. Settings remain in memory even if you remove the disc from the player or switch off the player. If you load a disc that has its settings memorized, the latest stop position is automatically recalled.

SCREEN SAVER

The screen saver picture appears when you leave the DVD Player in stop mode for about five minutes. After the Screen Saver has been engaged for about five minutes, the DVD Player will automatically turn itself off.

VIDEO MODE SETTING DVD-V VCD 2.0 VCD 1.1

- With certain discs, the playback picture may be flickering or Dot Crawl is shown on straight lines. That means Vertical interpolation or De-interlace is not perfectly matched with the disc. In this case, the picture quality may be improved by changing the video mode.
- To change the video mode, press and hold DISP about 3 seconds during disc playback. The new video mode number selected is displayed on the TV screen. Check whether the video quality has improved. If not, repeat the above procedure until picture quality is improved.
- Video mode change sequence: MODE1 → MODE2 → MODE3 → MODE1
- If you turn off the power, the video mode will be back to initial state (MODE1).

DETAILED DESCRIPTIONS FOR VIDEO MODES

MODE1: The source material of the DVD video (film material or video material) is determined from disc information.

MODE2: Suitable for playing film based content or video based material recorded by the progressive scan method.

MODE3: Suitable for playing video based content with comparatively little motion.

NOTE

The video mode setting only works when the Progressive Scan mode is set to "On" in the Setup menu.

Reference

TROUBLESHOOTING

Check the following guide for the possible cause of a problem before contacting service.

| SYMPTOM | CAUSE | CORRECTION |
|---|---|--|
| No power. | <ul style="list-style-type: none"> The power cord is disconnected. | <ul style="list-style-type: none"> Plug the power cord into the wall outlet securely. |
| The power is on, but the DVD player does not work. | <ul style="list-style-type: none"> No disc is inserted. | <ul style="list-style-type: none"> Insert a disc. (Check that the DVD or audio CD indicator in the display window is lit.) |
| No picture. | <ul style="list-style-type: none"> The TV is not set to receive DVD signal output. | <ul style="list-style-type: none"> Select the appropriate video input mode on the TV so the picture from the DVD player appears on the TV screen. |
| | <ul style="list-style-type: none"> The video cable is not connected securely. | <ul style="list-style-type: none"> Connect the video cable securely. |
| | <ul style="list-style-type: none"> The connected TV power is turned off. | <ul style="list-style-type: none"> Turn on the TV. |
| No sound. | <ul style="list-style-type: none"> The equipment connected with the audio cable is not set to receive DVD signal output. | <ul style="list-style-type: none"> Select the correct input mode of the audio receiver so you can listen to the sound from the DVD player. |
| | <ul style="list-style-type: none"> The audio cables are not connected securely. | <ul style="list-style-type: none"> Connect the audio cable securely. |
| | <ul style="list-style-type: none"> The power of the equipment connected with the audio cable is turned off. | <ul style="list-style-type: none"> Turn on the equipment connected with the audio cable. |
| | <ul style="list-style-type: none"> The Digital Audio Output is set to the wrong position. | <ul style="list-style-type: none"> Set the Digital Audio Output to the correct position, then turn on the DVD player again by pressing ON. |
| | <ul style="list-style-type: none"> The disc is dirty. | <ul style="list-style-type: none"> Clean the disc. |
| The playback picture is poor. | <ul style="list-style-type: none"> The disc is dirty. | <ul style="list-style-type: none"> Clean the disc. |
| The DVD player does not start playback. | <ul style="list-style-type: none"> No disc is inserted. | <ul style="list-style-type: none"> Insert a disc. (Check that the DVD or audio CD indicator in the DVD display is lit.) |
| | <ul style="list-style-type: none"> An unplayable disc is inserted. | <ul style="list-style-type: none"> Insert a playable disc. (Check the disc type, color system, and Regional code.) |
| | <ul style="list-style-type: none"> The disc is placed upside down. | <ul style="list-style-type: none"> Place the disc with the playback side down. |
| | <ul style="list-style-type: none"> The disc is not placed within the guide. | <ul style="list-style-type: none"> Place the disc on the disc tray correctly inside the guide. |
| | <ul style="list-style-type: none"> The disc is dirty. | <ul style="list-style-type: none"> Clean the disc. |
| | <ul style="list-style-type: none"> The Rating level is set. | <ul style="list-style-type: none"> Cancel the Rating function or change the rating level. |
| | <ul style="list-style-type: none"> The remote control is not pointed at the remote sensor of the DVD player. | <ul style="list-style-type: none"> Point the remote control at the remote sensor of the DVD player. |
| The remote control does not work properly. | <ul style="list-style-type: none"> The remote control is too far from the DVD player. | <ul style="list-style-type: none"> Operate the remote control within 23 ft (7 m). |
| | <ul style="list-style-type: none"> There is an obstacle in the path of the remote control and the DVD player. | <ul style="list-style-type: none"> Remove the obstacle. |
| | <ul style="list-style-type: none"> The batteries in the remote control are exhausted. | <ul style="list-style-type: none"> Replace the batteries with new ones. |
| | | |

TABLE OF LANGUAGES AND THEIR ABBREVIATIONS

Language Code List

Enter the appropriate code number for the initial settings "Disc Audio", "Disc Subtitle" and/or "Disc Menu"

| Code | Language | Code | Language | Code | Language | Code | Language | |
|------|-----------------|------|------------------|------|----------------|--------|------------|-------|
| 6566 | Abkhazian | 7074 | Fiji | 7678 | Lingala | 8373 | Singhalese | |
| 6565 | Afar | 7073 | Finnish | 7684 | Lithuanian | 8375 | Slovak | |
| 6570 | Afrikaans | 7082 | French | 7775 | Macedonian | 8376 | Slovenian | |
| 8381 | Albanian | 7089 | Frisian | 7771 | Malagasy | 8379 | Somali | |
| 6577 | Ameharic | 7176 | Galician | 7783 | Malay | 6983 | Spanish | |
| 6582 | Arabic | 7565 | Georgian | 7776 | Malayalam | 8385 | Sudanese | |
| 7289 | Armenian | 6869 | German | 7784 | Maltese | 8387 | Swahili | |
| 6583 | Assamese | 6976 | Greek | 7773 | Maori | 8386 | Swedish | |
| 6588 | Aymara | 7576 | Greenlandic | 7782 | Marathi | 8476 | Tagalog | |
| 6590 | Azerbaijani | 7178 | Guarani | 7779 | Moldavian | 8471 | Tajik | |
| 6665 | Bashkir | 7185 | Gujarati | 7778 | Mongolian | 8465 | Tamil | |
| 6985 | Basque | 7265 | Hausa | 7865 | Nauru | 8484 | Tatar | |
| 6678 | Bengali, Bangla | 7387 | Hebrew | 7869 | Nepali | 8469 | Telugu | |
| 6890 | Bhutani | 7273 | Hindi | 7879 | Norwegian | 8472 | Thai | |
| 6672 | Bihari | 7285 | Hungarian | 7982 | Oriya | 6679 | Tibetan | |
| 6682 | Breton | 7383 | Icelandic | 8065 | Panjabi | 8473 | Tigrinya | |
| 6671 | Bulgarian | 7378 | Indonesian | 8083 | Pashto, Pushto | 8479 | Tonga | |
| 7789 | Burmese | 7365 | Interlingua | 7065 | Persian | 8482 | Turkish | |
| 6669 | Byelorussian | 7165 | Irish | 8076 | Polish | 8475 | Turkmen | |
| 7577 | Cambodian | 7384 | Italian | 8084 | Portuguese | 8487 | Twì | |
| 6765 | Catalan | 7465 | Japanese | 8185 | Quechua | 8575 | Ukrainian | |
| 9072 | Chinese | 7487 | Javanese | 8277 | Rhaeto-Romance | 8582 | Urdu | |
| 6779 | Corsican | 7578 | Kannada | 8279 | Rumanian | 8590 | Uzbek | |
| 7282 | Croatian | 7583 | Kashmiri | 8285 | Russian | 8673 | Vietnamese | |
| 6783 | Czech | 7575 | Kazakh | 8377 | Samoan | 8679 | Volapük | |
| 6865 | Danish | 7589 | Kirghiz | 8365 | Sanskrit | 6789 | Welsh | |
| 7876 | Dutch | 7579 | Korean | 7168 | Scots | Gaelic | 8779 | Wolof |
| 6978 | English | 7585 | Kurdish | 8382 | Serbian | 8872 | Xhosa | |
| 6979 | Esperanto | 7679 | Laothian | 8372 | Serbo-Croatian | 7473 | Yiddish | |
| 6984 | Estonian | 7665 | Latin | 8378 | Shona | 8979 | Yoruba | |
| 7079 | Faroese | 7686 | Latvian, Lettish | 8368 | Sindhi | 9085 | Zulu | |

Reference

COUNTRY CODE LIST

Enter the appropriate code number for the initial setting "Country Code"

| Code | Country | Code | Country | Code | Country | Code | Country |
|------|--------------------------|------|-----------------------------------|------|---------------------------|------|--------------------------------|
| AD | Andorra | ER | Eritrea | LC | Saint Lucia | SC | Seychelles |
| AE | United Arab Emirates | ES | Spain | LI | Liechtenstein | SD | Sudan |
| AF | Afghanistan | ET | Ethiopia | LK | Sri Lanka | SE | Sweden |
| AG | Antigua and Barbuda | FI | Finland | LR | Liberia | SG | Singapore |
| AI | Anguilla | FJ | Fiji | LS | Lesotho | SH | Saint Helena |
| AL | Albania | FK | Falkland Islands | LT | Lithuania | SI | Slovenia |
| AM | Armenia | FM | Micronesia | LU | Luxembourg | SJ | Svalbard and Jan Mayen |
| AN | Netherlands Antilles | FO | Faroe Islands | LV | Latvia Islands | SK | Slovak Republic |
| AO | Angola | FR | France | LY | Libya | SL | Sierra Leone |
| AQ | Antarctica | FX | France (European Territory) | MA | Morocco | SM | San Marino |
| AR | Argentina | GA | Gabon | MC | Monaco | SN | Senegal |
| AS | American Samoa | GB | Great Britain | MD | Moldavia | SO | Somalia |
| AT | Austria | GD | Grenada | MG | Madagascar | SR | Suriname |
| AU | Australia | GE | Georgia | MH | Marshall Islands | ST | Saint Tome and Principe |
| AW | Aruba | GF | French Guyana | MK | Macedonia | SU | Former USSR |
| AZ | Azerbaijan | GH | Ghana | ML | Mali | SV | El Salvador |
| BA | Bosnia-Herzegovina | GI | Gibraltar | MM | Myanmar | SY | Syria |
| BB | Barbados | GL | Greenland | MN | Mongolia | SZ | Swaziland |
| BD | Bangladesh | GM | Gambia | MP | Northern Mariana Islands | TC | Turks and Caicos Islands |
| BE | Belgium | GN | Guinea | MQ | Martinique (French) | TD | Chad |
| BF | Burkina Faso | GP | Guadeloupe (French) | MR | Mauritania | TF | French Southern Territories |
| BG | Bulgaria | GQ | Equatorial Guinea | MS | Montserrat | TG | Togo |
| BH | Bahrain | GR | Greece | MT | Malta | TH | Thailand |
| BI | Burundi | GS | S. Georgia & S. Sandwich Isls. | MU | Mauritius | TJ | Tadjikistan |
| BJ | Benin | GT | Guatemala | MV | Maldives | TK | Tokelau |
| BM | Bermuda | GU | Guam (USA) | MW | Malawi | TM | Turkmenistan |
| BN | Brunei Darussalam | GW | Guinea Bissau | MX | Mexico | TN | Tunisia |
| BO | Bolivia | GY | Guyana | MY | Malaysia | TO | Tonga |
| BR | Brazil | HK | Hong Kong | MZ | Mozambique | TP | East Timor |
| BS | Bahamas | HM | Heard and McDonald Islands | NA | Namibia | TR | Turkey |
| BT | Bhutan | HN | Honduras | NC | New Caledonia (French) | TT | Trinidad and Tobago |
| BV | Bouvet Island | HR | Croatia | NE | Niger | TV | Tuvalu |
| BW | Botswana | HT | Haiti | NF | Norfolk Island | TW | Taiwan |
| BY | Belarus | HU | Hungary | NG | Nigeria | TZ | Tanzania |
| BZ | Belize | ID | Indonesia | NL | Netherlands | UA | Ukraine |
| CA | Canada | IE | Ireland | NO | Norway | UG | Uganda |
| CC | Cocos (Keeling) Islands | IL | Israel | NP | Nepal | UK | United Kingdom |
| CF | Central African Republic | IN | India | NR | Nauru | UM | USA Minor Outlying Islands |
| CG | Congo | IO | British Indian Ocean Territory | NU | Niue | US | United States |
| CH | Switzerland | IQ | Iraq | NZ | New Zealand | UY | Uruguay |
| CI | Ivory Coast | IR | Iran | OM | Oman | UZ | Uzbekistan |
| CK | Cook Islands | IS | Iceland | PA | Panama | VA | Vatican City State |
| CL | Chile | IT | Italy | PE | Peru | VC | Saint Vincent & Grenadines |
| CM | Cameroon | JM | Jamaica | PF | Polynesia (French) | VE | Venezuela |
| CN | China | JO | Jordan | PG | Papua New Guinea | VG | Virgin Islands (British) |
| CO | Colombia | JP | Japan | PH | Philippines | VI | Virgin Islands (USA) |
| CR | Costa Rica | KE | Kenya | PK | Pakistan | VN | Vietnam |
| CS | Former Czechoslovakia | KG | Kyrgyzstan | PL | Poland | VU | Vanuatu |
| CU | Cuba | KH | Cambodia | PM | Saint Pierre and Miquelon | WF | Wallis and Futuna Islands |
| CV | Cape Verde | KI | Kiribati | PN | Pitcairn Island | WS | Samoa |
| CX | Christmas Island | KM | Comoros | PR | Puerto Rico | YE | Yemen |
| CY | Cyprus | KN | Saint Kitts & Nevis Anguilla | PT | Portugal | YT | Mayotte |
| CZ | Czech Republic | KP | North Korea | PW | Palau | YU | Yugoslavia |
| DE | Germany | KR | South Korea | PY | Paraguay | ZA | South Africa |
| DJ | Djibouti | KW | Kuwait | QA | Qatar | ZM | Zambia |
| DK | Denmark | KY | Cayman Islands | RE | Reunion (French) | ZR | Zaire |
| DM | Dominica | KZ | Kazakhstan | RO | Romania | ZW | Zimbabwe |
| DO | Dominican Republic | LA | Laos | RU | Russian Federation | | |
| DZ | Algeria | LB | Lebanon | RW | Rwanda | | |
| EC | Ecuador | | | SA | Saudi Arabia | | |
| EE | Estonia | | | SB | Solomon Islands | | |
| EG | Egypt | | | | | | |
| EH | Western Sahara | | | | | | |

GENERAL

| | |
|-----------------------|-------------------------------|
| Power requirements | AC 120V, 60 Hz |
| Power consumption | 12W |
| Dimensions (approx.) | 435 X 38 X 241 mm (w x h x d) |
| Weight (approx.) | 2.4 kg |
| Operating temperature | 5°C to 35°C (41°F to 95°F) |
| Operating humidity | 5 % to 90 % |

SYSTEM

| | |
|-----------------------|--|
| Laser | Semiconductor laser, wavelength 650 nm |
| Signal system | NTSC |
| Frequency response | DVD (PCM 96 kHz): 8 Hz to 44 kHz DVD (PCM 48 kHz): 8 Hz to 22 kHz CD: 8 Hz to 20 kHz |
| Signal-to-noise ratio | More than 100dB (ANALOG OUT connectors only) |
| Harmonic distortion | Less than 0.008% |
| Dynamic range | More than 100 dB (DVD) More than 95 dB (CD) |

OUTPUTS

| | |
|------------------------------|---|
| VIDEO OUT | 1 Vp-p 75 ohms, sync negative, RCA jack x 1 |
| S-VIDEO OUT | (Y) 1.0 V (p-p), 75 ohms, negative sync, Mini DIN 4-pin x 1 (C) 0.3 V (p-p) 75 ohms |
| COMPONENT VIDEO OUT | (Y) 1.0 V (p-p), 75 ohms, negative sync, RCA jack x 1 (Pb)/(Pr) 0.7 V (p-p), 75 ohms, RCA jack x 2 |
| Audio output (digital audio) | 0.5 V (p-p), 75 ohms, RCA jack x 1 |
| Audio output (optical audio) | 5 V (p-p), 75 ohms, Optical connector x 1 |
| Audio output (analog audio) | 2.0 Vrms (1 KHz, 0 dB), 600 ohms, RCA jack (LF, RF) x 2 |

INPUTS

| | |
|---------------------|--|
| + 12V Trigger input | center pin +12V at 50 mA, subminiature banana jack x 1 |
|---------------------|--|

ACCESSORIES

| | |
|----------------|---|
| Video cable | 1 |
| Audio cable | 1 |
| Remote control | 1 |
| Batteries | 2 |

Design and specifications are subject to change without notice.

Manufactured under license from Dolby Laboratories. Dolby, MLP Lossless and the double-D symbol are trademarks of Dolby Laboratories. Confidential unpublished works. Copyright 1992-1997 Dolby Laboratories. All rights reserved.

"DTS" and "DTS Digital Out" are trademarks of Digital Theater Systems, Inc.



www.NADelectronics.com

**©2004 NAD ELECTRONICS INTERNATIONAL
A DIVISION OF LENBROOK INDUSTRIES LIMITED**

All rights reserved. No part of this publication may be reproduced, stored or transmitted in any form without the written permission of NAD Electronics International

T514 Manual AH Version 10/04